

Installation Instructions

Thru-Hull Transducer

Model 525

IMPORTANT – PLEASE READ THESE INSTRUCTIONS COMPLETELY BEFORE PROCEEDING WITH THE INSTALLATION OF THE THRU-HULL TRANSDUCER.

WARNING: DO NOT INSTALL THIS TRANSDUCER IN AN ALUMINUM HULL. THE HULL WILL BE DAMAGED BY ELECTROLYSIS.

APPLICATION CONSIDERATIONS:

- Plastic housings are recommended for fiberglass or metal hulls. Never install a plastic Thru-Hull housing into a wooden boat hull. The swelling of the wood may overstress the plastic housing causing a fracture to occur.
- Bronze housings are recommended for wood or fiberglass hulls. Never install a bronze housing in a metal hull, because electrolytic corrosion can occur.
- Stainless steel housings are recommended for metal hulls to prevent electrolytic corrosion from occurring.
- Never install a metal housing in a hull with a positive ground.

MOUNTING LOCATION:

The transducer must be positioned in the hull at a location that assures a smooth, bubble-free flow of water across the transducer face (especially at high speeds). Under no circumstances should it be located directly aft of any hull fitting or other protrusion on the hull.

The best location is aft of amidships and as close to the keel or centerline of the boat as possible. On sailboats, placement too close to the keel should be avoided because of the “shading” of the sound beam. Forward of the keel is usually a good position.

Acoustic noise is another item to take into consideration when determining a location of the transducer. Vessel generated noise from

the propellers, shafts and other machinery should be avoided also.

After determining the best location from the outside, consider the need for room inside the hull to tighten the mounting hardware.

FAIRING BLOCK:

Unless the transducer can be installed in a fairly flat area on the hull (dead rise angle should not exceed 10°), a fairing/leveling block must be used to assure that the sonar beam is projected downward. A fairing block cut to the shape of the transducer must be sawed at an angle to match the dead rise. See Figure 1. A prefabricated fairing block is available from your dealer.

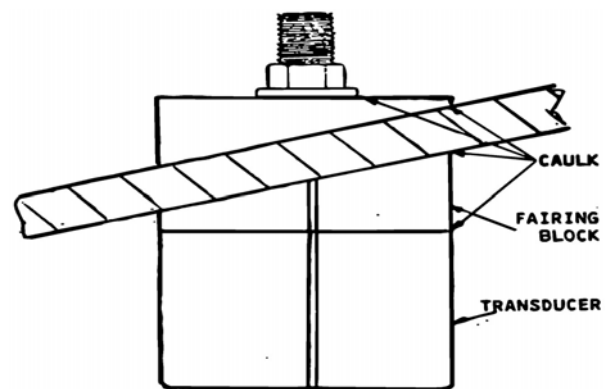

Figure 1

INSTALLATION:

WARNING: Always wear the proper safety goggles, dust mask and clothing during the installation procedure.

Installation Instructions

Thru-Hull Transducer

Model 525

Note: For a cored fiberglass hull, the thru hull transducer installation should only be performed by a trained technician. Improper sealing of the core material can lead to premature failure or possible water leakage.

Once a location has been determined, and prior to drilling any holes in the hull. Inspect the location from the inside of the hole to ensure that the location you have chosen will not interfere with any bulkheads, plumbing or any other obstruction.

1. Drill a small hole first from the inside of the hull at the desired location for the transducer. This will be a locating hole for the final drilling.
2. From the outside, enlarge the locating hole to 1/4" or whatever size necessary for the pilot drill of the 7/8" (22mm) hole saw. Drill the pilot hole vertically, followed by the hole saw.
3. After drilling, remove any rough edges around the hole and thoroughly clean and sand the inside and outside surfaces around the hole.
4. Remove the hull nut from the transducer housing.
5. Apply a generous amount, approximately 1/16" thick, of a good marine adhesive/sealing compound around the lip of the housing that contacts the hull. The compound should also extend up the side wall of the housing, 1/4" higher than the combined thickness of the hull and hull nut. This will ensure there is sealant in the threads to seal the hull and to hold the hull nut securely in place.
6. From the outside of the hull, insert the transducer housing and gently rotate the housing to squeeze out and excess sealant.

7. From the inside, thread down the hull nut until it makes contact with either the hull or fairing block, if used. The hull nut should then be tighten to a snug fit using slip joint pliers. Make sure the outer housing does not rotate and disturb the sealant during the tightening of the hull nut.

CAUTION: DO NOT OVERTIGHTEN HULL NUT.

8. Remove any excess sealant on the outside of the hull to ensure there is smooth water flow over the face of the transducer.

CABLE ROUTING:

In routing the cable to the sounder, avoid placing it near or parallel to other electrical cables, particularly ignition and alternator wiring. Use care when routing the cable through bulkheads and other parts of the vessel to avoid tearing the cable jacket thus exposing it to the harsh environment.

CHECKING FOR LEAKS:

CAUTION: *Never install a thru-hull transducer and leave the boat in the water unattended for several days.*

After installation of the thru-hull transducer, and the proper time allotment for the adhesive to setup correctly, place the vessel in the water and immediately check around the thru-hull transducer for leaks. Small leaks by not be immediately visible. It is best NOT to leave the vessel in the water for more than 3 hours before checking it again for leaks. If a leak is observed, repeat the "Installation" procedure with extra care taken during steps 5 thru 8.